

MULTI DOMILED BL-PMRTB

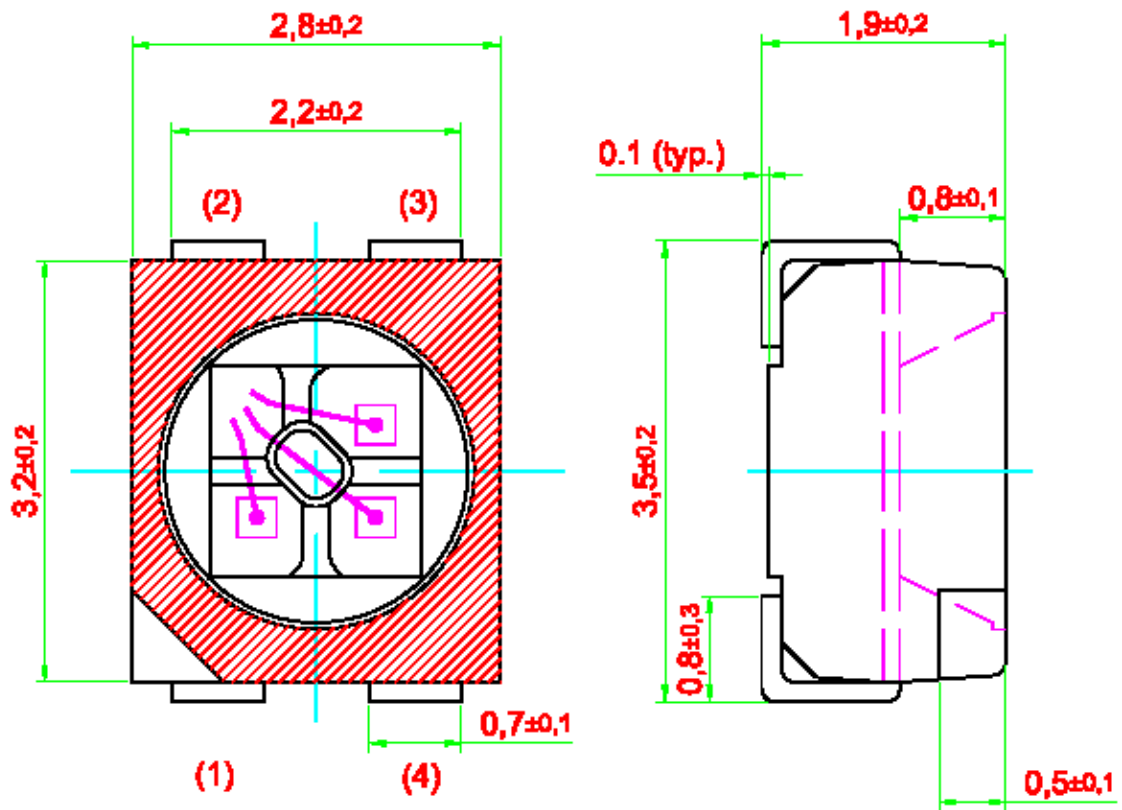

- (1) Cathode Red**
- (2) Common Anode**
- (3) Cathode Blue**
- (4) Cathode True Green / Green**

- High brightness tri-color surface mount LED.
- Capable for all video-standards. The RGB-LED chips can be controlled separately.
- 120° viewing angle.
- Small package outline (LxWxH) of 2.8 x 3.2 x 1.9 mm.
- Qualified according to JEDEC moisture sensitivity Level 2.
- Compatible to both IR reflow soldering and TTW soldering.



Part Ordering Number	Color, λ_{dom} (nm)	Luminous Intensity @ $I_f = 20mA$. I_v (mcd)
----------------------	-----------------------------	---

	Chip#1	Chip#2	Chip#3	Chip#1	Chip#2	Chip#3
BL-PMRTB-CJB	RED	TRUE	BLUE	100.0 ... 200.0	140.0 ... 285.0	35.5 ... 100.0
	625	GREEN 525	470			
- BIN R3 S3 N3				100.0 ... 140.0	140.0 ... 200.0	35.5 ... 50.5
- BIN R3 S3 P3				100.0 ... 140.0	140.0 ... 200.0	50.5 ... 71.5
- BIN R3 S3 Q3				100.0 ... 140.0	140.0 ... 200.0	71.5 ... 100.0
- BIN R3 T3 N3				100.0 ... 140.0	200.0 ... 285.0	35.5 ... 50.5
- BIN R3 T3 P3				100.0 ... 140.0	200.0 ... 285.0	50.5 ... 71.5
- BIN R3 T3 Q3				100.0 ... 140.0	200.0 ... 285.0	71.5 ... 100.0
- BIN S3 S3 N3				140.0 ... 200.0	140.0 ... 200.0	35.5 ... 50.5
- BIN S3 S3 P3				140.0 ... 200.0	140.0 ... 200.0	50.5 ... 71.5
- BIN S3 S3 Q3				140.0 ... 200.0	140.0 ... 200.0	71.5 ... 100.0
- BIN S3 T3 N3				140.0 ... 200.0	200.0 ... 285.0	35.5 ... 50.5
- BIN S3 T3 P3				140.0 ... 200.0	200.0 ... 285.0	50.5 ... 71.5
- BIN S3 T3 Q3				140.0 ... 200.0	200.0 ... 285.0	71.5 ... 100.0

1. Reel comes in a quantity of 1025 and 2050 units per reel.
2. Luminous intensity is measured with an accuracy of $\pm 11\%$.
3. All electrical and optical data are measured at room temperature; $T_a = 25^\circ C$.

Half Group For Luminous Intensity

Only one IV group is allowed for each chip within a reel.

Groupings	Min. (mcd)	Max. (mcd)
N3	35.5	50.5
P3	50.5	71.5
Q3	71.5	100.0
R3	100.0	140.0
S3	140.0	200.0
T3	200.0	285.0



Wavelength Grouping.

If wavelength binning is required, only one wavelength group is allowed for each chip within a reel.

Color	Group	Wavelength distribution (nm)
Red	Full	620 – 630
True Green	Full	521 - 536
	A	521 - 526
	B	526 - 531
	C	531 - 536
Blue	Full	465 - 475
	A	465 - 470
	B	470 - 475

Dominant wavelength is measured with an accuracy of ±1 nm.

Electrical Characteristics at T_a = 25 °C

	V _f at I _f =20mA; (V)		Temperature coefficient of V _f (I _f =20mA; -10°C<T<100°C)
	Typ.	Max	Typ. (mV/K)
Red	1.8	2.45	-2.0
True Green	3.7	4.25	-3.6
Blue	3.6	4.25	-3.1

Optical Characteristics at T_A = 25 °C

	Temperature coefficient (I _f =20mA; -10°C<T<100°C, typ.)		View Angle (deg.)
	λ _{peak} (nm/K)	λ _{dom.} (nm/K)	
Red	0.15	0.05	120
True Green	0.04	0.03	
Blue	0.04	0.02	

Absolute Maximum Ratings

	Maximum Value		Unit
	Red	Green, Blue	
DC forward current.	30	20	mA
Peak pulse current. ($t_p \leq 10 \mu s$, Duty cycle = 0.005)	1000	200	mA
Reverse voltage.	12	5	V
Power consumption.	75	85	V
Thermal resistance junction/ambient, $R_{th JA}$			K/W
1 chip on	480	530	
3 chips on	770	820	
Thermal resistance junction/solder point, $R_{th JS}$			K/W
1 chip on	260	290	
3 chips on	420	470	
LED junction temperature.	125		°C
Operating temperature.	-40 ... +100		°C
Storage temperature.	-40 ... +100		°C

Recommended Solder Pad

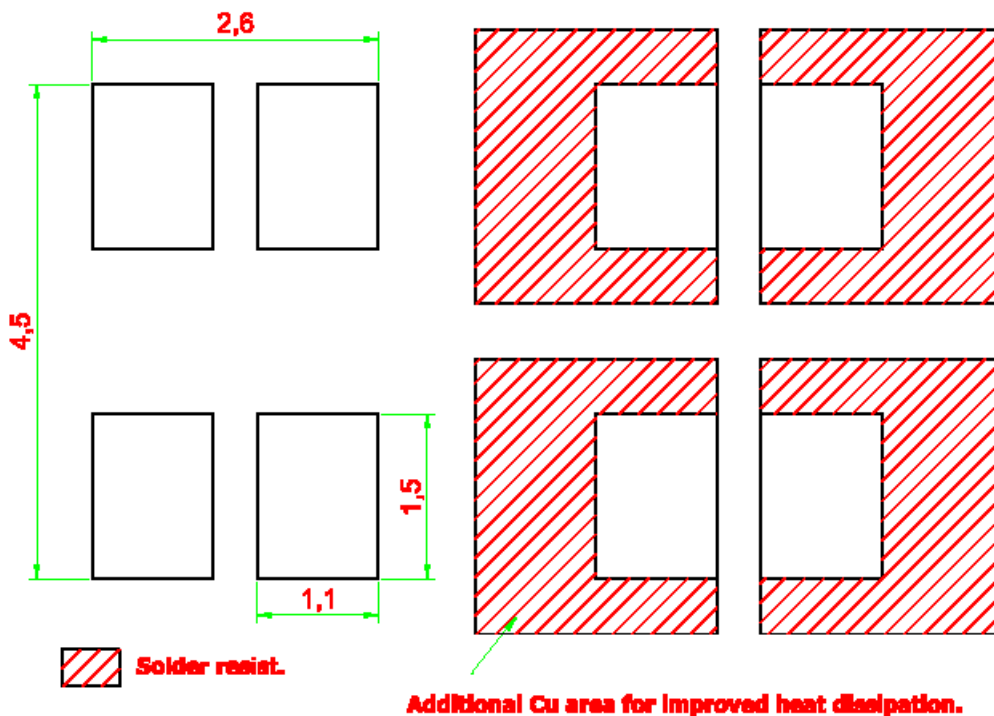



Luminous intensity vs. forward current.

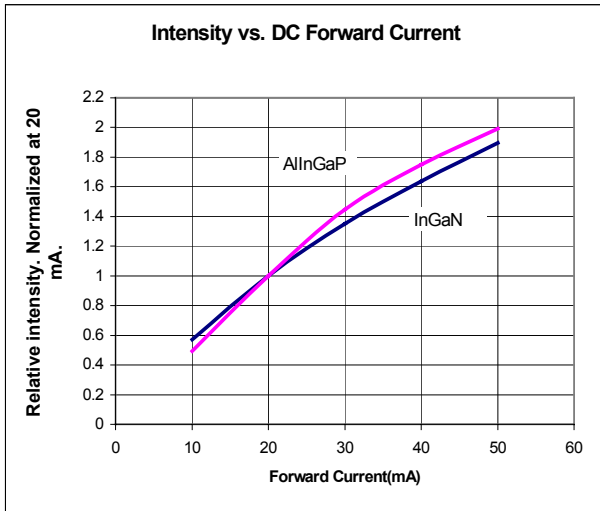

Wavelength vs. forward current.

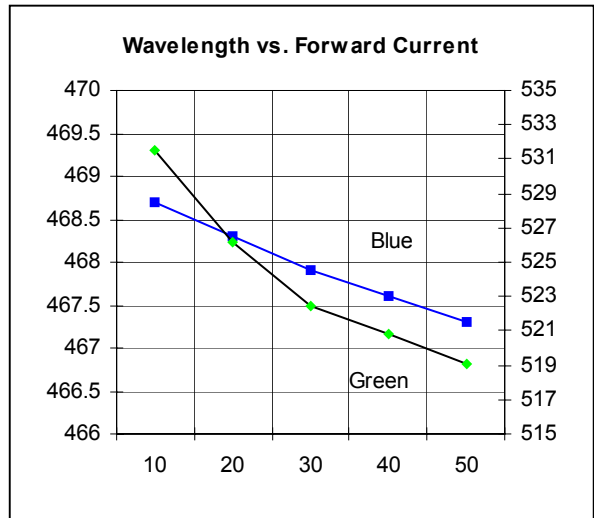

Wavelength Distribution.

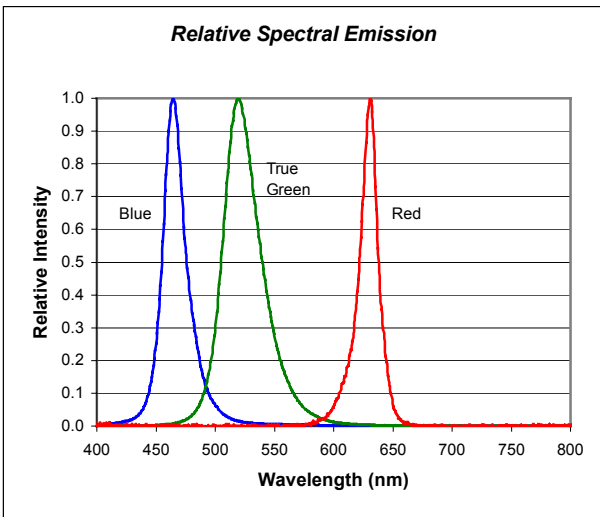

Forward current vs. forward voltage.

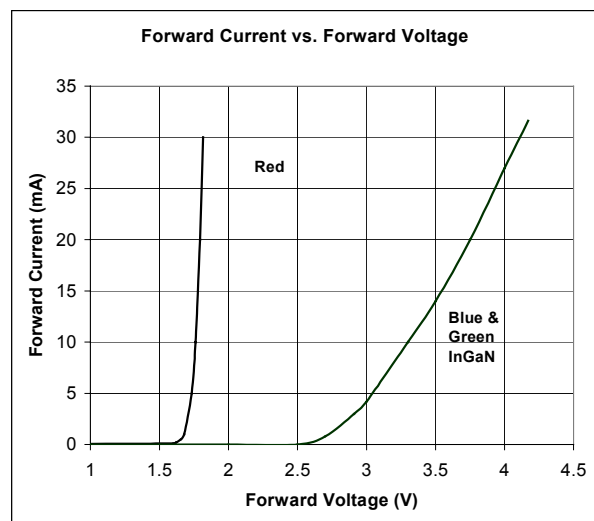

Radiation pattern.

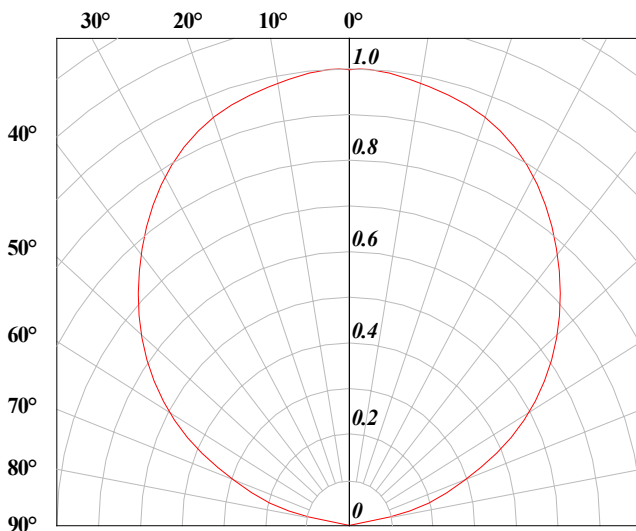



Max forward current vs. temperature (1 chip on)

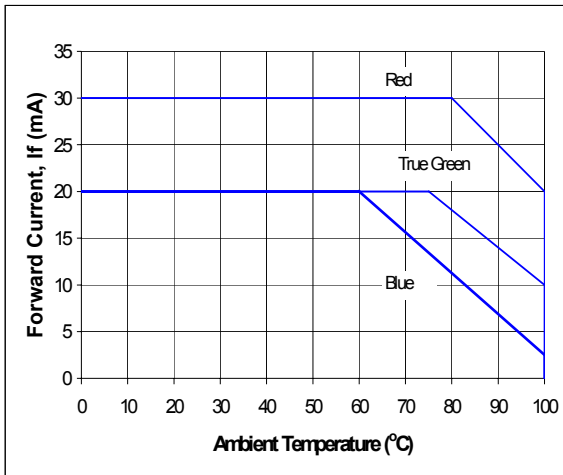

Max forward current vs. temperature (3 chips on)

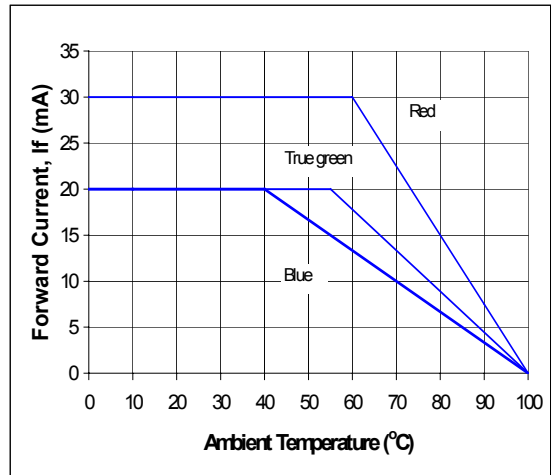

Max forward current vs. temperature (1 chip on)

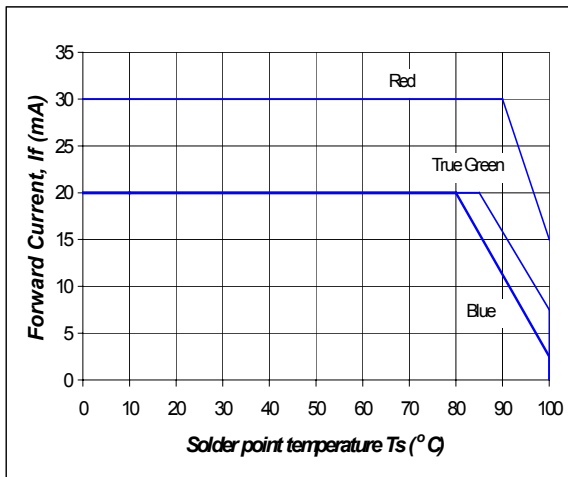

Max forward current vs. temperature (3 chips on)

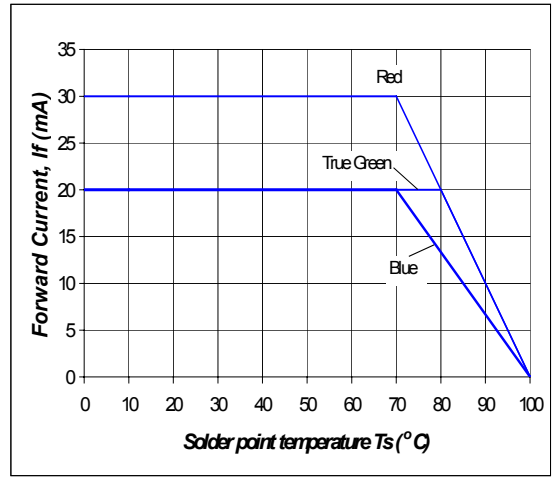

Taping And Orientation.

Reels come in quantity of 1025 or 2050 units.

Reel diameter is 180 mm.

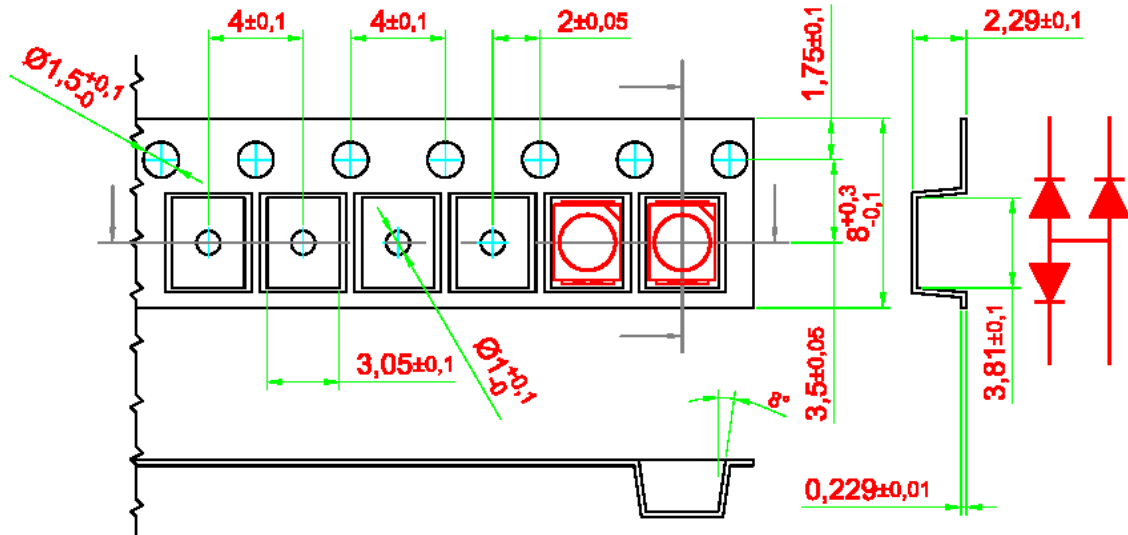

200 mm min. for $\phi 180$ reel.

480 mm min. for $\phi 180$ reel.

200 mm min. for $\phi 330$ reel.

960 mm min. for $\phi 330$ reel.

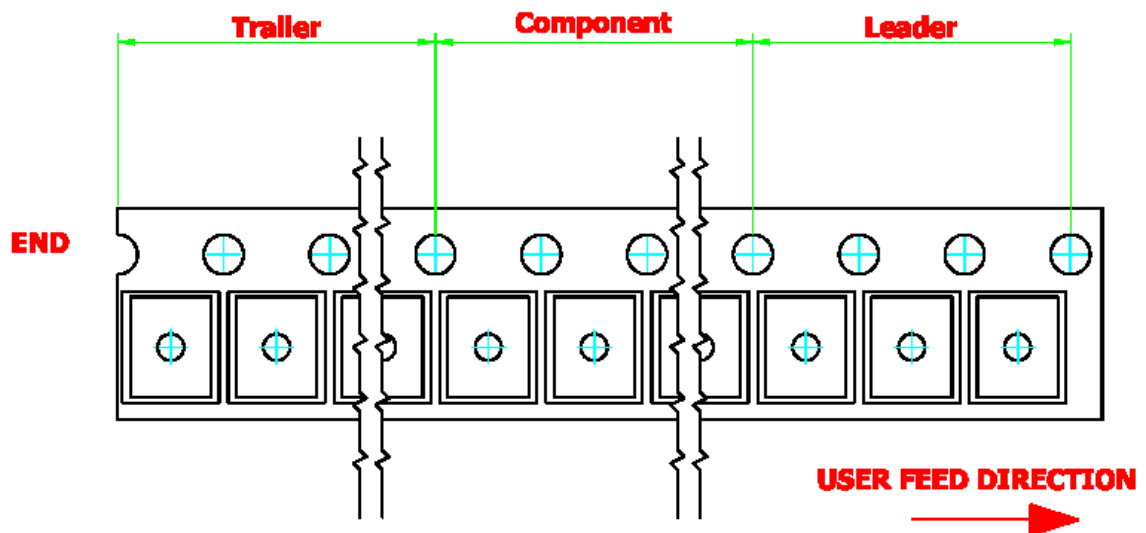



Recommended IR-reflow Soldering Profile.

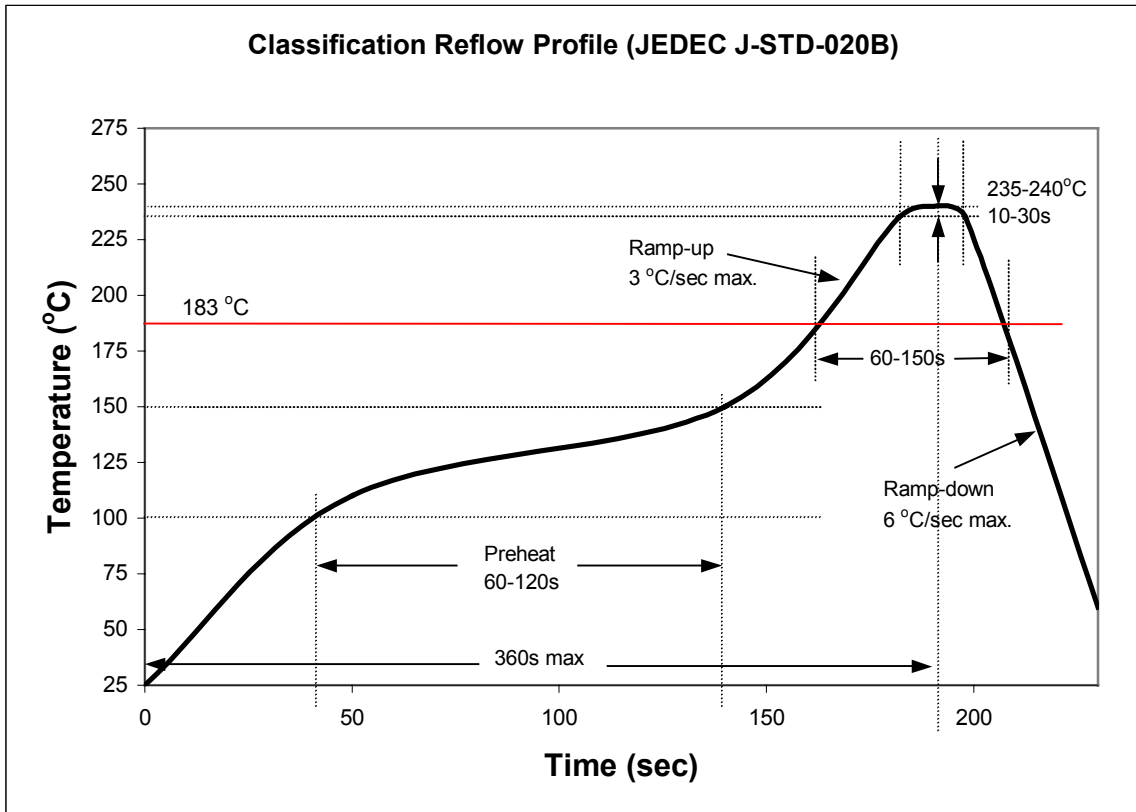

Recommended Pb Free IR-Reflow Soldering Profile.

